

## TC488 Display Manual

### 1. Outlook&Size

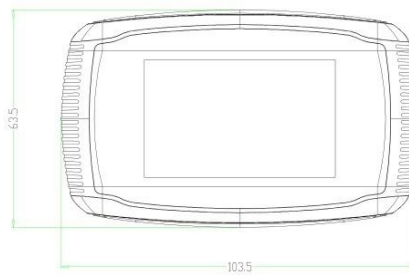

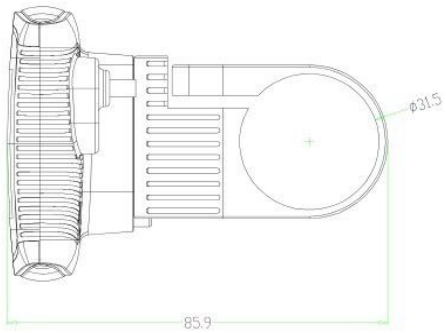

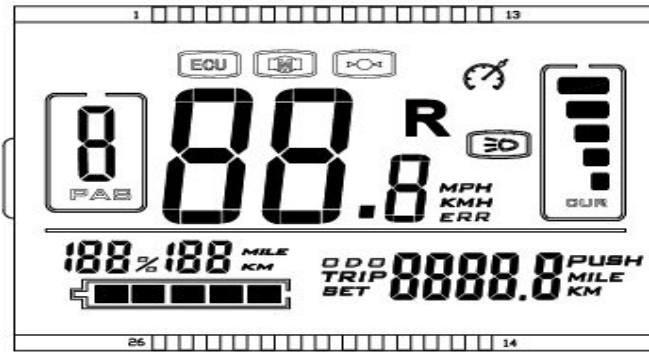





## 2. Display Area:



## 3. Extended Function Display Summary:

Function \ Item	TC428	TC430	TC470	TC480	TC485	TC488
Battery Indicator	○	○	○	○	○	○
Auto Dormancy	○	○	○	○	○	○
3 Speed PAS	○	○	○			
Manual Cruise		○			○	
Pedal/Throttle Propel	○	○	○			
5 Speed PAS				○	○	○
Instantaneous Power				○	○	○
Speed				○	○	○
Trip/ODO				○	○	○
Average Speed						○
Intelligent Error Codes				○	○	○
KM/Mile Switch				○	○	○

#### 4. TC-488 Screen Display:

Display Contents	Function	Description
	Speed	Unit: KM/H or MP/H
	ODO/TRIP	ODO (Odometer/ Trip switch by the function key
	Battery Indicator	SOC(State of Charge) Display
	Light Instruction	Display, lighting backlight
	6KM/H	<b>Display, 6 km/H pattern</b>
	Motor Fault	Display,motor hall fault
	Controller Fault	Display,controller failure
	Current Instruction	Show the current current value points level 5
	PAS Instruction	1-5 file display speed PAS

## 5. Operating instructions

Keys	Operating Mode	Display	Function	Description
	1x briefly		Power On/Off	Single click to open the system, all the contents show one time
	1x briefly		Backlight/ Headlight Switch	After system opened, click again to control the background lights and lamps light up and shut down
	1x Long		OFF	1x Long to close the system
	1x Long		ODO/TRIP Switch	Click to switch ODO/Trip
	1x briefly		PAS Increase	Every click means increasing 1 gear PAS, totally 5 gears
	1x Long		6KM/H	Long time press to enter the 6km/h implement mode
	1x briefly		PAS Reduce	Every click means increasing 1 gear PAS, totally 5 gears. A flashing at lowest (0), no power at this time
	1x Long		Trip Reset	Long press to reset trip

## 6.Configuration Instructions:

- Work Voltage: 36V(Lithium Battery)
- This Display adapts to the controller of DMHC company, and also with the DMHC high precision speed sensor.
- Closed the system power.
- Adapted motor: Motor with speed outputting function,Using this motor can show the speed accurately.